



2/2-way Angle-Seat Valve for medium up to +180 °C, DN 15-50

- High flow rates
- Very high cycle life
- Clamp body according to EN ISO 2852, BS 4825 or ASME BPE
- Deliverable with flow direction below or above seat
- Simple conversion of the circuit function

Type 2000 can be combined with...



Type 8691

Control head



Type 8690

Pneum. control unit with feedback



Type 1062

Electrical position feedback

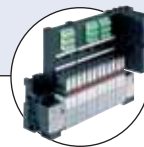

Type 8640/8644

Valve block

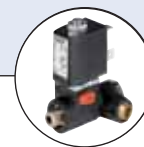

Type 6012/6014 P

Pilot valve

The externally piloted angle-seat valve is operated with a single or double-acting piston actuator. The actuator is available in two different materials, PA and PPS depending on the ambient temperature. The reliable self-adjusting packing gland provides high sealing integrity. High flow rates are attained with the stainless steel 2-way body.

These maintenance-free and robust valves can be retrofitted with a comprehensive range of accessories for position indication, stroke limitation or manual override.

For valves with port connection threaded port and weld end please see separate datasheets.

¹⁾ **Note:** For PA actuators in the sizes 50 and 63, the combination of max. medium temperature and max. ambient temperature is as shown in the following chart

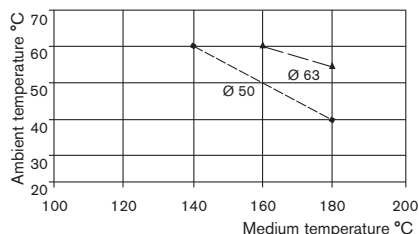

| Technical data | |
|---|--|
| Orifice | DN15 to 50 |
| Body materials | Stainless steel 316L |
| Actuator material | PA (PPS on request) |
| Seal material | PTFE (NBR, FKM, EPDM on request) |
| Medium | Water, alcohol, oils, fuel, hydraulic fluids, salt solution, alkali solutions, organic solvents, steam |
| Viscosity | Max. 600 mm ² /s |
| Packing gland (with silicone grease) | PTFE V-rings with spring compensation |
| Medium temperature¹⁾ | -10 to +180 °C with PTFE seal |
| Ambient temperature | |
| PA actuator ¹⁾ | -10 to +60 °C |
| PPS actuator ¹⁾ Ø 50-80 | +5 to +140 °C |
| PPS actuator ¹⁾ Ø 100-125 | +5 to +90 °C |
| Installation | As required, preferably with actuator in upright position |
| Control medium | Neutral gases, air |
| Max. pilot pressure | |
| Actuator size Ø 50-80 | PA and PPS 10 bar |
| Actuator size Ø 100 | PA 10 bar |
| Actuator size Ø 100 | PPS 7 bar |
| Actuator size Ø 125 | PA and PPS 7 bar |
| Port connection acc. | EN ISO 2852, BS 4825, ASME BPE on request DIN 32676 |
| Surface finish | Standard Ra, internal ≤ 3.2 µm on request Int. Ra ≤ 0.6 µm (external cast surface) electropolished |

Content

| Valve specifications | | System spec. On/Off Classic | Request for quotation |
|---|--------|--|--------------------------|
|  Type 2000 clamp | |  Type 8801-YA/ 8803-YA | Type 8801-YA/ 8803-YA |
| Technical data & ordering info. | p. 1-6 | Ordering info. & technical data | p. 7-10 |
| | | | p. 11 |

Materials Type 2000 clamp

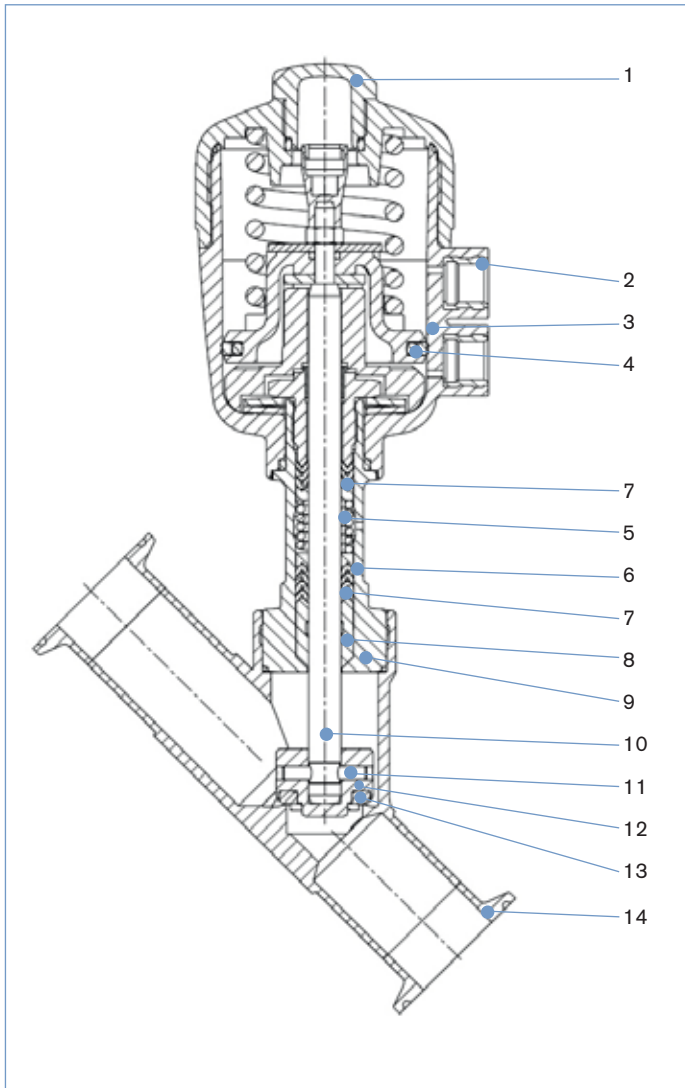

| | | |
|-----------|----------------------|--|
| 1 | Transparent cap | PC (with PPS actuator; PSU) |
| 2 | Pilot air ports | Stainless steel 1.4305 |
| 3 | Actuator | PA (PPS on request) |
| 4 | Piston seal | NBR (with PPS actuator; FKM) |
| 5 | Spring | Stainless steel 1.4310 |
| 6 | Tube ²⁾ | Stainless steel 1.4401 Stainless steel 316L ³⁾ |
| 7 | V-Seals | PTFE (FKM on request) |
| 8 | Wiper | PTFE PEEK ¹⁾ |
| 9 | Nipple ²⁾ | Stainless steel 1.4401 Stainless steel 316L ³⁾ |
| 10 | Spindle | Stainless steel 1.4401 |
| 11 | Pins | Stainless steel 1.4401 |
| 12 | Swivel plate | Stainless steel 1.4401 |
| 13 | Seal | PTFE (NBR, FKM, EPDM on request) |
| 14 | Valve body | Stainless steel 316L |

¹⁾ For actuator size 100 mm and 125 mm

²⁾ Single piece with actuator size 63 mm to 125 mm

³⁾ For actuator size 63 mm to 125 mm

Technical data for Type 2000 clamp with flow direction below seat (for gas and liquid)

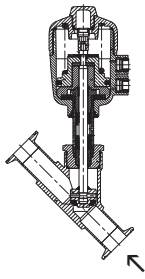

Flow direction below seat

| Orifice [mm] | Actuator size [mm] | Kv value water (m³/h) | Min. pilot pressure CFA [bar] | Max. operating pressure up to +180° | | Weight [kg] |
|--------------|--------------------|-----------------------|-------------------------------|-------------------------------------|-----------|-------------|
| | | | | CFA [bar] | CFB [bar] | |
| 15 | 50 | 4.2 | 3.9 | 16 | 16 | 0.8 |
| 20 | 50 | 8.0 | 3.9 | 11 | 16 | 1.0 |
| 25 | 50 | 14.5 | – | – | 16 | 1.2 |
| | 63 | 19 | 4.2 | 11 | 16 | 1.8 |
| 32 | 63 | 27 | 4.2 | 6 | 16 | 2.3 |
| | 80 | 28 | 5.0 | 14 | 16 | 3.1 |
| 40 | 63 | 35 | – | – | 16 | 2.7 |
| | 80 | 38 | 5.0 | 9 | 16 | 3.5 |
| 50 | 63 | 49 | – | – | 13 | 4.0 |
| | 100 | 55 | 4.4 | 7.2 | – | 7.0 |

Kv value water [m³/h]: Measured at +20 °C, 1 bar pressure at valve inlet and free outlet
 Pressure values [bar]: Measured as overpressure to the atmospheric pressure

Pilot pressure diagram with control function B and flow direction below seat

Diagram 1

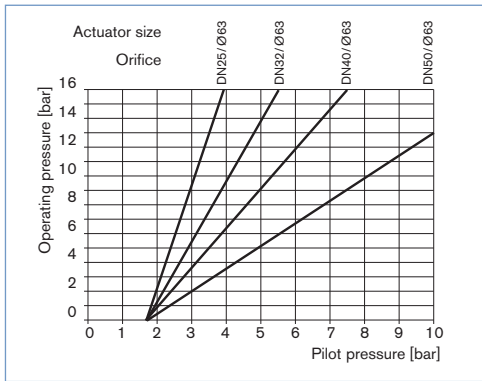
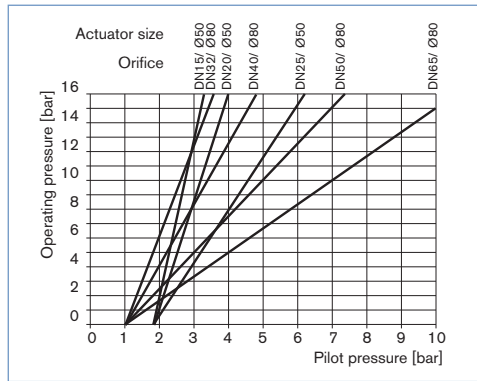

Diagram 2



Ordering chart for valves with flow direction below seat (further versions on request)

Valves with clamp connection acc. to ISO 2852, ASME BPE or BS 4825, body in stainless steel, actuator material PA, Ra internal ≤ 3.2 µm

| Control function | Orifice [mm] | Actuator size Ø [mm] | Port connection Clamp external Ø [mm] | | | Min. pilot pressure [bar] | Operating pressure up to 180 °C [bar] | Item no. | | |
|------------------|--------------|----------------------|---------------------------------------|----------|---------|---------------------------|---------------------------------------|----------|----------|---------|
| | | | ISO 2852 | ASME BPE | BS 4825 | | | ISO 2852 | ASME BPE | BS 4825 |
| | 15 | 50 | 34.0 | 25.0 | 25.0 | 3.9 | 16 | 415 070 | 175 574 | 183 245 |
| | 20 | 50 | 50.5 | 25.0 | 25.0 | 3.9 | 11 | 415 071 | 175 575 | 183 246 |
| | 25 | 63 | 50.5 | 50.5 | 50.5 | 4.2 | 11 | 415 072 | 175 576 | 175 576 |
| | 32 | 80 | 50.5 | – | – | 5 | 14 | 415 073 | – | – |
| | 40 | 80 | 64.0 | 50.5 | 50.5 | 5 | 9 | 415 074 | 175 579 | 175 579 |
| | 50 | 100 | 77.5 | 64.0 | 64.0 | 4.4 | 7.2 | 415 075 | 175 580 | 175 580 |
| | 15 | 50 | 34.0 | 25.0 | 25.0 | see diagram 1 and 2 above | 16 | 415 076 | – | – |
| | 20 | 50 | 50.5 | 25.0 | 25.0 | | 16 | 415 077 | – | – |
| | 25 | 50 | 50.5 | 50.5 | 50.5 | | 16 | 415 078 | – | – |
| | 32 | 63 | 50.5 | – | – | | 16 | 415 079 | – | – |
| | 40 | 63 | 64.0 | 50.5 | 50.5 | | 16 | 415 080 | – | – |
| 50 | 63 | 77.5 | 64.0 | 64.0 | 13 | | 415 081 | – | – | |

i Further versions on request

Material
 Seal: NBR, FKM, EPDM
 Actuator: PPS

Port connections
 Clamp acc. DIN 32676,
 Weld end, threaded port

Additional
 Surface finish: int. Ra ≤ 0.8 µm electro polished,
 int. Ra ≤ 0.4 µm electro polished

Control function
 Double-acting actuator

Approvals
 GL, SIL

Mediums temperature
 Valves for mediums temperature up to +200°C or down to -40°C

Technical data for Type 2000 clamp with flow direction above seat (only for gas and steam)

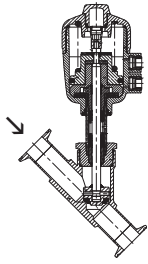

| Orifice [mm] | Actuator size [mm] | Kv value water (m³/h) | Max. operating pressure up to +180° | Weight [kg] |
|--------------|--------------------|-----------------------|-------------------------------------|-------------|
| 15 | 50 | 4.2 | 16 | 0.8 |
| 20 | 50 | 8.0 | 16 | 1.0 |
| 25 | 63 | 19.0 | 16 | 1.8 |
| 32 | 63 | 27.0 | 16 | 2.2 |
| 40 | 63 | 35.0 | 16 | 2.7 |
| 50 | 63 | 49.0 | 16 | 4.0 |

Kv value water [m³/h]: Measured at +20 °C, 1 bar pressure at valve inlet and free outlet
 Pressure values [bar]: Measured as overpressure to the atmospheric pressure

Flow direction above seat

Attention!

Valves with flow direction above the seat are only conditionally usable for liquid medium .
 There is a danger of waterhammer!

Pilot pressure diagram with control function A and flow direction above seat

Diagram 3

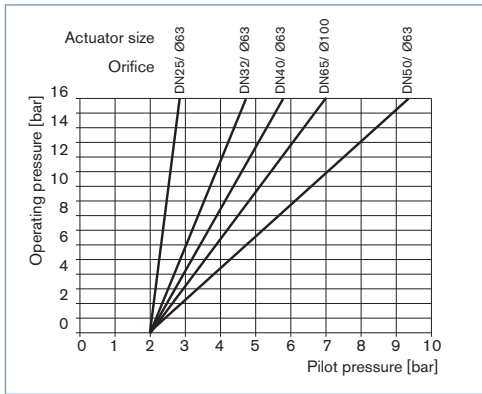
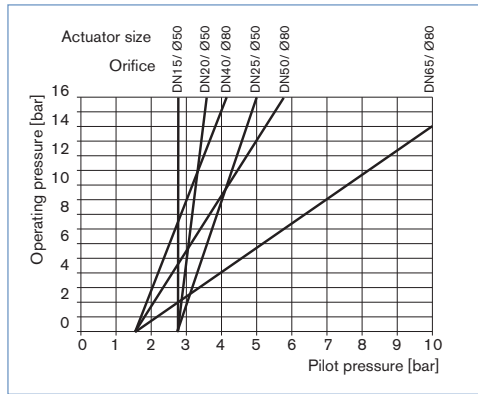

Diagram 4



Ordering chart for valves with flow direction above seat (further versions on request)

Valves with clamp connection acc. to ISO 2852, ASME BPE or BS 4825, body in stainless steel, actuator material PA, Ra internal ≤ 3.2 µm

| Control function | Orifice [mm] | Actuator size Ø [mm] | Port connection Clamp external Ø [mm] | | | Min. pilot pressure [bar] | Operating pressure up to 180 °C [bar] | Item no. | | |
|------------------|--------------|----------------------|---------------------------------------|----------|---------|---------------------------|---------------------------------------|----------|----------|---------|
| | | | ISO 2852 | ASME BPE | BS 4825 | | | ISO 2852 | ASME BPE | BS 4825 |
| | 15 | 50 | 34.0 | 25.0 | 25.0 | see diagram 3 and 4 above | 16 | 415 082 | 183 247 | 183 249 |
| | 20 | 50 | 50.5 | 25.0 | 25.0 | | 16 | 415 083 | 183 248 | 183 264 |
| | 25 | 63 | 50.5 | 50.5 | 50.5 | | 16 | 415 084 | 183 265 | 183 265 |
| | 32 | 63 | 50.5 | - | - | | 16 | 415 085 | - | - |
| | 40 | 63 | 64.0 | 50.5 | 50.5 | | 16 | 415 086 | 183 266 | 183 266 |
| | 50 | 63 | 77.5 | 64.0 | 64.0 | | 16 | 415 087 | 183 267 | 183 267 |

Further versions on request

Material
 Seal: NBR, FKM, EPDM
 Actuator: PPS

Port connections
 Clamp acc. DIN 32676,
 Weld end, threaded port

Additional
 Surface finish: int. Ra ≤ 0.8 µm electro polished,
 int. Ra ≤ 0.4 µm electro polished

Control function
 Double-acting actuator

Approvals
 GL, SIL

Mediums temperature
 Valves for mediums temperature up to +200°C or down to -40°C

Ordering chart for accessories

3/2-way pilot valves with banjo bolts

Seal material valve FKM, seal material banjo bolt NBR

| Valve for actuator size [Ø mm] | Type | Pressure inlet P (valve body) | Service port A (banjo bolt) | Orifice [mm] | Qn value air [l/min] | Pressure range [bar] | Electrical coil connection Ind. Std. | Power consumption [W] | Item no. Voltage/frequency [V/Hz] | |
|--------------------------------|-------|-------------------------------|-----------------------------|--------------|----------------------|----------------------|--------------------------------------|-----------------------|-----------------------------------|---------|
| | | | | | | | | | 024/DC | 230/50 |
| 50-63 | 6012P | Tube fitting ø6 mm | G 1/4 | 1.2 | 48 | 0-10 | Form B | 4 | 552 283 | 552 286 |
| 50-125 | 6014P | G 1/4 | G 1/4 | 2 | 120 | 0-10 | Form A | 8 | 424 103 | 424 107 |

Cable plug Type 2507, Form B or Type 2508, Form A

| | Item no. |
|--|----------|
| Type 2507, Form B Industrial standard, 0 to 250 V without circuitry (Type 6012 P) | 423 845 |
| Type 2508, Form A acc. DIN EN 175301-803, 0 to 250 V without circuitry (Type 6014 P, Type 0331P) | 008 376 |

For further accessories see datasheet for Type 1062 or the accessories datasheet Type 2XXX for the full options programme.

Note: For design reasons, some of the accessories cannot be supplied for actuator size Ø 40 mm. Please request the accessories datasheet Type 2XXX.

Dimensions Type 2000 clamp [mm]

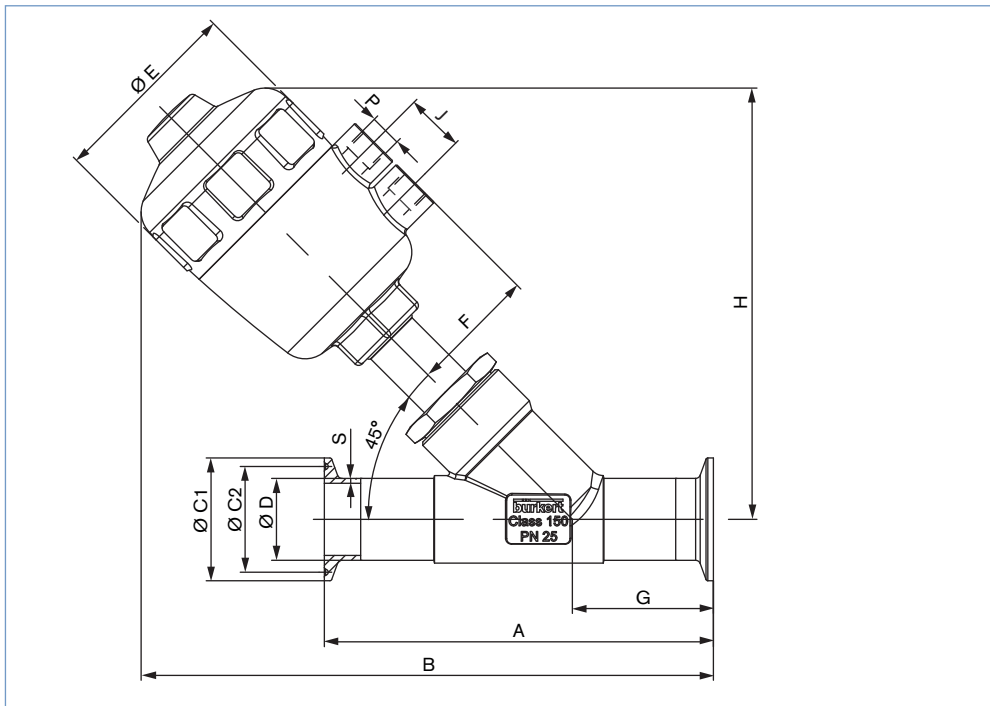

Dimensions according to EN ISO 2852 [mm]

| DN [mm] | Actuator size Ø | Ø E | H | F | P | J | A | B | Ø C1 | Ø C2 | Ø D | G | S |
|---------|-----------------|-----|-----|----|-------|----|-----|-------|------|------|------|------|-----|
| 15 | 50 | 64 | 145 | 44 | G 1/4 | 24 | 130 | 194 | 34.0 | 27.5 | 21.3 | 49 | 1.6 |
| 20 | 50 | 64 | 149 | 44 | G 1/4 | 24 | 150 | 205.5 | 50.5 | 43.5 | 26.9 | 56.5 | 1.6 |
| 25 | 50 | 64 | 152 | 44 | G 1/4 | 24 | 160 | 210 | 50.5 | 43.5 | 33.7 | 58 | 2 |
| | 63 | 80 | 178 | 52 | G 1/4 | 24 | 160 | 236 | 50.5 | 43.5 | 33.7 | 58 | 2 |
| 32 | 63 | 80 | 188 | 52 | G 1/4 | 24 | 180 | 245.5 | 50.5 | 43.5 | 42.4 | 57.5 | 2 |
| | 80 | 101 | 209 | 60 | G 1/4 | 24 | 180 | 266.5 | 50.5 | 43.5 | 42.4 | 57.5 | 2 |
| 40 | 63 | 80 | 191 | 52 | G 1/4 | 24 | 200 | 260 | 64 | 56.5 | 48.3 | 69 | 2 |
| | 80 | 101 | 213 | 60 | G 1/4 | 24 | 200 | 282 | 64 | 56.5 | 48.3 | 69 | 2 |
| 50 | 63 | 80 | 209 | 52 | G 1/4 | 24 | 230 | 286.5 | 77.5 | 70.5 | 60.3 | 77.5 | 2.6 |
| | 100 | 127 | 277 | 73 | G 1/4 | 30 | 230 | 354.5 | 77.5 | 70.5 | 60.3 | 77.5 | 3.6 |

Dimensions Type 2000 clamp [mm], continued

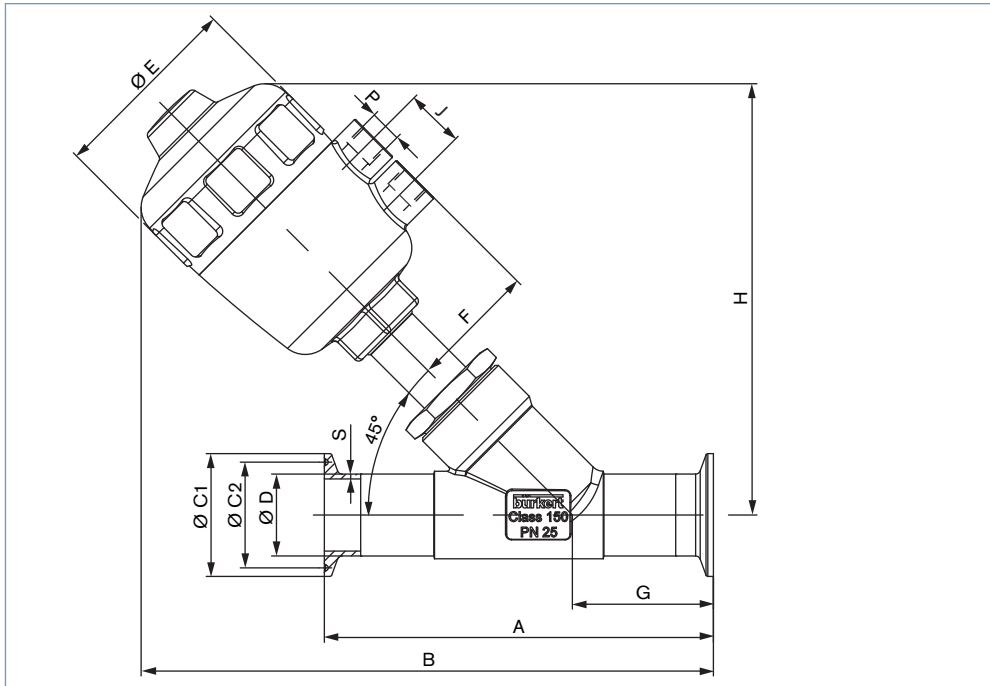

Dimensions according to ASME BPE [mm]

| DN [mm] | Actuator size Ø | Ø E | H | F | P | J | A | B | Ø C1 | Ø C2 | Ø D | G | S |
|---------|-----------------|-----|-----|----|-------|----|-----|-------|------|------|-------|------|------|
| 15 | 50 | 64 | 145 | 44 | G 1/4 | 24 | 130 | 194 | 25.2 | 20.2 | 12.7 | 49 | 1.65 |
| 20 | 50 | 64 | 149 | 44 | G 1/4 | 24 | 150 | 205.5 | 25.2 | 20.2 | 19.05 | 56.5 | 1.65 |
| 25 | 50 | 64 | 152 | 44 | G 1/4 | 24 | 160 | 210 | 50.5 | 43.5 | 25.4 | 58 | 1.65 |
| | 63 | 80 | 178 | 52 | G 1/4 | 24 | 160 | 230 | 50.5 | 43.5 | 25.4 | 58 | 1.65 |
| 40 | 63 | 80 | 191 | 52 | G 1/4 | 24 | 200 | 260 | 50.5 | 43.5 | 38.1 | 69 | 1.65 |
| | 80 | 101 | 213 | 60 | G 1/4 | 24 | 200 | 282 | 50.5 | 43.5 | 38.1 | 69 | 1.65 |
| 50 | 63 | 80 | 209 | 52 | G 1/4 | 24 | 230 | 286.5 | 64.0 | 56.5 | 50.8 | 77.5 | 1.65 |
| | 100 | 127 | 277 | 73 | G 1/4 | 30 | 230 | 354.5 | 64.0 | 56.5 | 50.8 | 77.5 | 1.65 |

Dimensions according to BS 4825 [mm]

| DN [mm] | Actuator size Ø | Ø E | H | F | P | J | A | B | Ø C1 | Ø C2 | Ø D | G | S |
|---------|-----------------|-----|-----|----|-------|----|-----|-------|------|------|-------|------|------|
| 15 | 50 | 64 | 145 | 44 | G 1/4 | 24 | 130 | 194 | 25.2 | 20.2 | 12.7 | 49 | 1.2 |
| 20 | 50 | 64 | 149 | 44 | G 1/4 | 24 | 150 | 205.5 | 25.2 | 20.2 | 19.05 | 56.5 | 1.2 |
| 25 | 50 | 64 | 152 | 44 | G 1/4 | 24 | 160 | 210 | 50.5 | 43.5 | 25.4 | 58 | 1.65 |
| | 63 | 80 | 178 | 52 | G 1/4 | 24 | 160 | 236 | 50.5 | 43.5 | 25.4 | 58 | 1.65 |
| 40 | 63 | 80 | 191 | 52 | G 1/4 | 24 | 200 | 260 | 50.5 | 43.5 | 38.1 | 69 | 1.65 |
| | 80 | 101 | 213 | 60 | G 1/4 | 24 | 200 | 282 | 50.5 | 43.5 | 38.1 | 69 | 1.65 |
| 50 | 63 | 80 | 209 | 52 | G 1/4 | 24 | 230 | 286.5 | 64.0 | 56.5 | 50.8 | 77.5 | 1.65 |
| | 100 | 127 | 277 | 73 | G 1/4 | 30 | 230 | 354.5 | 64.0 | 56.5 | 50.8 | 77.5 | 1.65 |

Dimensions according to DIN 32676 [mm]

| DN [mm] | Actuator size Ø | Ø E | H | F | P | J | A | B | Ø C1 | Ø C2 | Ø D | G | S |
|---------|-----------------|-----|-----|----|-------|----|-----|-------|------|------|------|------|-----|
| 15 | 50 | 64 | 145 | 44 | G 1/4 | 24 | 130 | 194 | 34.0 | 27.5 | 19.0 | 49 | 1.5 |
| 20 | 50 | 64 | 149 | 44 | G 1/4 | 24 | 150 | 205.5 | 34.0 | 27.5 | 23.0 | 56.5 | 1.5 |
| 25 | 50 | 64 | 152 | 44 | G 1/4 | 24 | 160 | 210 | 50.5 | 43.5 | 29.0 | 58 | 1.5 |
| | 63 | 80 | 178 | 52 | G 1/4 | 24 | 160 | 236 | 50.5 | 43.5 | 29.0 | 58 | 1.5 |
| 32 | 63 | 80 | 188 | 52 | G 1/4 | 24 | 180 | 245.5 | 50.5 | 43.5 | 35.0 | 57.5 | 1.5 |
| | 80 | 101 | 209 | 60 | G 1/4 | 24 | 180 | 266.5 | 50.5 | 43.5 | 35.0 | 57.5 | 1.5 |
| 40 | 63 | 80 | 191 | 52 | G 1/4 | 24 | 200 | 260 | 50.5 | 43.5 | 41.0 | 69 | 1.5 |
| | 80 | 101 | 213 | 60 | G 1/4 | 24 | 200 | 282 | 50.5 | 43.5 | 41.0 | 69 | 1.5 |
| 50 | 63 | 80 | 209 | 52 | G 1/4 | 24 | 230 | 286.5 | 64.0 | 56.5 | 53.0 | 77.5 | 1.5 |
| | 100 | 127 | 277 | 73 | G 1/4 | 30 | 230 | 354.5 | 64.0 | 56.5 | 53.0 | 77.5 | 1.5 |

**2000 clamp
System On/Off Classic
8801-YA/8803-YA**

Ordering information for valve system On/Off Classic Type 8801-YA/8803-YA

A valve system On/Off Classic Type 8801-YA/8803-YA consists of an angle-seat valve Type 2000 and a valve actuation system control head Type 8691, a pneumatic control unit Type 8690 or an electrical position feedback Type 1062 (see separate datasheets).

For the configuration of further valve systems please use the "Request for quotation" on p. 11 [go to page](#)

You order two components and receive a complete assembled and certified valve.

Ordering the valve system On/Off Classic Type 8801-YA/8803-YA

**Angle-seat valve
Type 2000 clamp**



Control units



8691



8690



1062

**Angle-seat valve with
desired control unit**

For port connections weld end and threaded port, see separate datasheets



**Valve system
On/Off Classic
Type 8801-YA-H
2000 + 8691**



**Valve system
On/Off Classic
Type 8801-YA-K
2000 + 8690**



**Valve system
On/Off Classic
Type 8803-YA
2000 + 1062**

When you click on the orange box "More info." below, you will come to our website for the resp. product where you can download the datasheet.

Control head Type 8691



More info.

The new generation of integrated control heads for combination with actuators from the process valve series Type 20xx/21xx is specially designed for the requirements of hygienic process environments. The intelligent control head, Type 8691, detects the valve position by means of a contact-free analog position sensor circumventing excessive wear of mechanical parts. Single or double-acting actuators are controlled via the integral pilot valve. Communication interfaces AS-Interface and DeviceNet are available as options.

Main customer benefits:

- Automatic setting of the control head at the push of a button
- Even under dirty or dark environments, a clearly visible status display due to powerful LEDs
- Monitoring and diagnosis: Process valve systems with field bus interface used in modern plant processes
- Integrated pilot valve with manual actuation
- Air intake filter enhances the process valve system availability
- Simple and reliable actuator adaptations allowing additional actuators of the process valve series, Type 20xx or actuators from other manufacturers to be used

**Pneumatic control unit
Type 8690**



More info.

The new generation of integrated controllers for combination with actuators from the process valve series Type 20xx/21xx is specially designed for the requirements of hygienic process environments. The pneumatic control unit Type 8690 combines electrical position feedback and pneumatic control for single or double-acting actuators, and is also optionally available as an intrinsically safe model to ATEX.

Main customer benefits:

- Integrated pilot valve with manual actuation
- Air intake filter enhances the process valve system availability
- Simple and reliable actuator adaptations allowing additional actuators of the process valve series, Type 20xx or actuators from other manufacturers to be used

**Electrical Position Feedback
Type 1062**



More info.

Positions are electrically signaled according to switch type:

- open,
- closed or
- open and closed.

LEDs provide optical position indication (except for Namur Ex-version). Mechanical or inductive switches are housed in a compact splash-proof enclosure. The position indicator can be rotated 360° and is easily fitted to the valve. Trip cams do not require adjustment. The unit only needs to be screwed on and connected to be ready for operation.

Dimensions for valve system On/Off Classic Type 8801-YA-H [mm]

Dimensions valve system On/Off Classic Type 8801-YA-H with TopControl Type 8691 [mm]

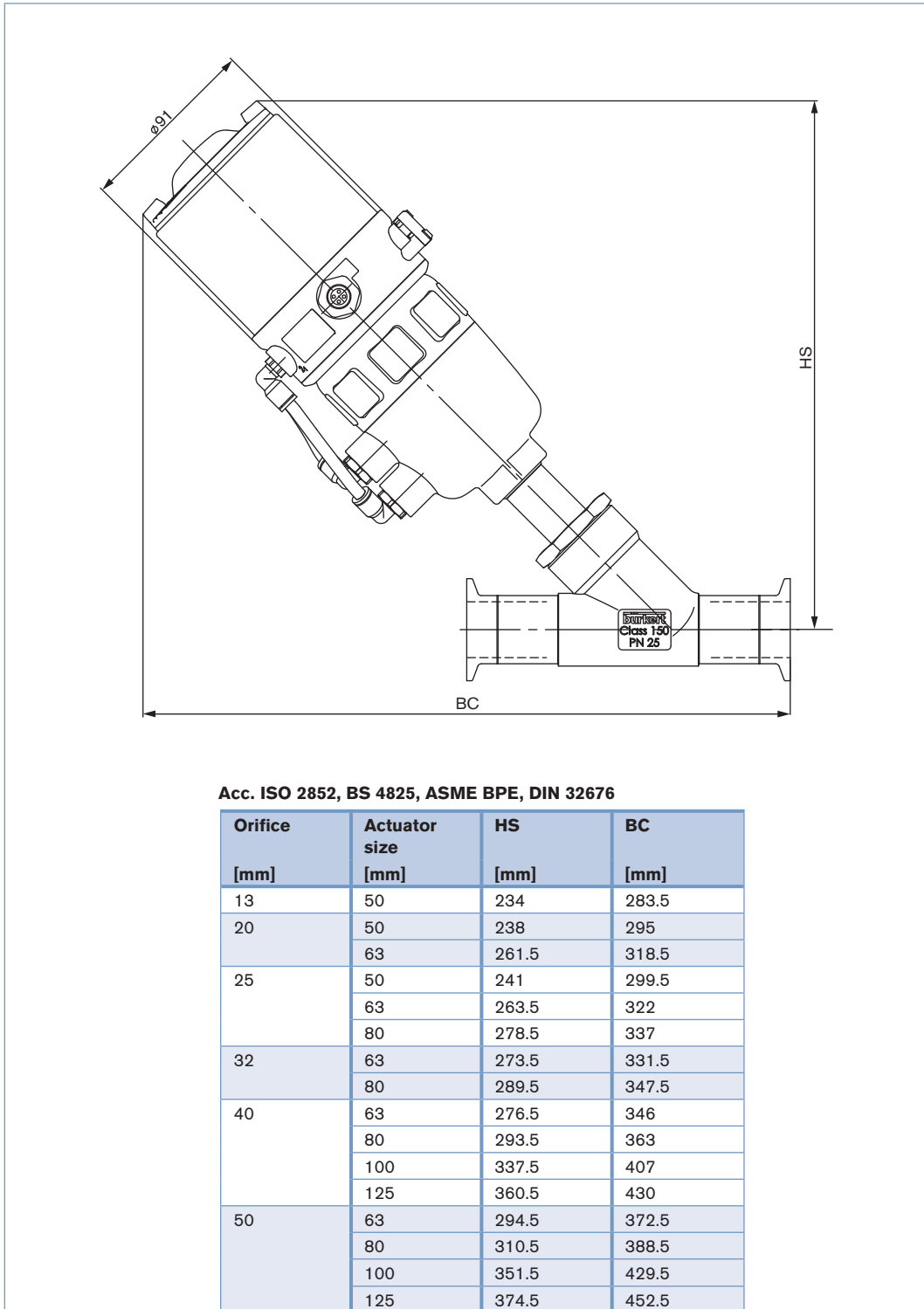

Dimensions for valve system On/Off Classic Type 8801-YA-K [mm]

Dimensions valve system On/Off Classic Type 8801-YA-K with TopControl Type 8690 [mm]

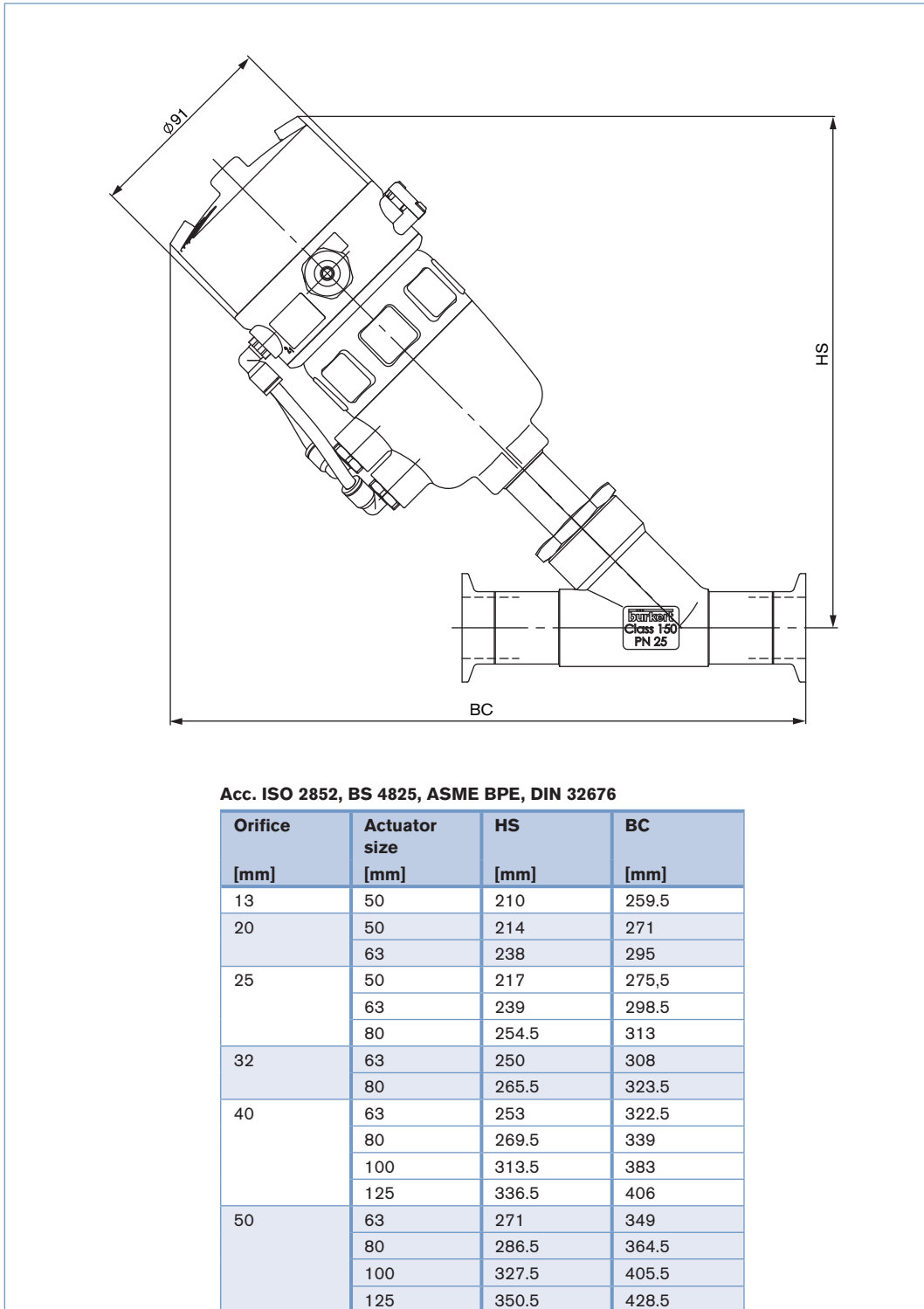

Dimensions for valve system On/Off Classic Type 8803-YA [mm]

Dimensions valve system On/Off Classic Type 8803-YA with electrical position feedback Type 1062 [mm]

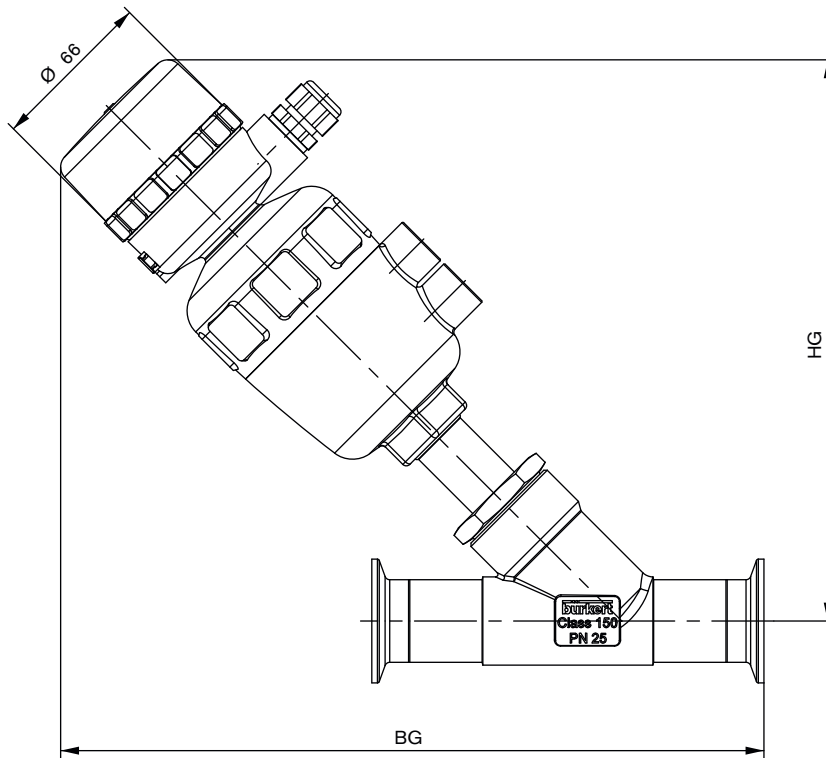

Acc. to EN ISO 2852 [mm]

| Orifice [mm] | Actuator size \varnothing [mm] | HG [mm] | BG [mm] |
|--------------|----------------------------------|---------|---------|
| 15 | 50 | 200 | 249 |
| 20 | 50 | 204 | 261 |
| 25 | 50 | 207 | 265 |
| | 63 | 230 | 288 |
| 32 | 63 | 240 | 298 |
| | 80 | 255 | 313 |
| 40 | 63 | 243 | 312 |
| | 80 | 259 | 328 |
| 50 | 63 | 261 | 339 |
| | 100 | 319 | 397 |

Acc. to ASME BPE and BS 4825 [mm]

| Orifice [mm] | Actuator size \varnothing [mm] | HG [mm] | BG [mm] |
|--------------|----------------------------------|---------|---------|
| 15 | 50 | 200 | 249 |
| 20 | 50 | 204 | 261 |
| 25 | 50 | 207 | 265 |
| | 63 | 230 | 288 |
| 40 | 63 | 243 | 312 |
| | 80 | 259 | 328 |
| 50 | 63 | 261 | 339 |
| | 100 | 319 | 397 |

Note
You can fill out the fields directly in the PDF file before printing out the form.

Valve system On/Off Classic Type 8801-YA/8803-YA – request for quotation

Please fill out and send to your nearest Bürkert facility* with your inquiry or order

| | |
|---------------|----------------|
| Company | Contact person |
| Customer no. | Department |
| Address | Tel./Fax |
| Postcode/town | E-Mail |

= mandatory fields to fill out Quantity Required delivery date

Operating data

| | | | | |
|---|---------------------------------|--------------------------------|------------------------------|----------------------|
| Pipeline | DN | <input type="text"/> | PN | <input type="text"/> |
| Pipe material | <input type="text"/> | | | |
| Process medium | <input type="text"/> | | | |
| Type of medium | <input type="checkbox"/> Liquid | <input type="checkbox"/> Steam | <input type="checkbox"/> Gas | |
| Flow rate (Q, Q _N , W) ¹⁾ | <input type="text"/> | standard | <input type="text"/> | unit |
| Temperature at valve inlet | <input type="text"/> | | | |
| Absolute pressure at valve inlet | <input type="text"/> | | | |

¹⁾ standard unit: Liquid Q = m³/h; Steam W = kg/h; Gas Q_N = Nm³/h

Valve features

| | | | |
|-----------------------|--|---|--|
| Actuator material | <input type="checkbox"/> PA | <input type="checkbox"/> PPS | |
| Body material | <input type="checkbox"/> Stainless steel | <input type="checkbox"/> Gunmetal | |
| Seat sealing material | <input type="checkbox"/> PTFE <input type="checkbox"/> NBR | <input type="checkbox"/> Other <input type="text"/> | |
| Nominal pressure | PN | <input type="text"/> | |
| Nominal size | DN | <input type="text"/> | |
| Type of connection | <input type="checkbox"/> Welded | <input type="checkbox"/> Internal thread | <input type="checkbox"/> Clamp |
| Standard connection | <input type="checkbox"/> ISO | <input type="checkbox"/> DIN | <input type="checkbox"/> ANSI <input type="checkbox"/> JIS <input type="checkbox"/> Other <input type="text"/> |
| Function | <input type="checkbox"/> NC ²⁾ | <input type="checkbox"/> NO ²⁾ | <input type="checkbox"/> Double-acting |
| Pilot pressure | <input type="text"/> | min. | <input type="text"/> |

²⁾ NC: normally closed by spring action; NO: normally open by spring action

Control unit features

Click on the orange box "More info." below... you will come to our website for the resp. product where you can download the datasheet.

| Pneumatic Control Unit | Control Head | Electrical position feedback |
|---|---|---|
| <input type="checkbox"/> Type 8691 More info. | <input type="checkbox"/> Type 8690 More info. | <input type="checkbox"/> Type 1062 More info. |
| Pneumatic function <input type="checkbox"/> Single-acting <input type="checkbox"/> Double-acting Pilot air ports <input type="checkbox"/> Push-in connector external ø 6 mm or 1/4" <input type="checkbox"/> Thread G 1/8" Communication <input type="checkbox"/> ASI <input type="checkbox"/> Multipol M12 <input type="checkbox"/> Flat cable clip, 1 m cable <input type="checkbox"/> DeviceNet Please specify item no. if known: <input type="text"/> | Pneumatic function <input type="checkbox"/> Single-acting <input type="checkbox"/> Double-acting <input type="checkbox"/> Without pilot valve Position feedback <input type="checkbox"/> 1x inductive <input type="checkbox"/> 2x inductive <input type="checkbox"/> 1x inductive (NAMUR) <input type="checkbox"/> 2x inductive (NAMUR) <input type="checkbox"/> 1x mechanical <input type="checkbox"/> 2x mechanical Supply voltage <input type="checkbox"/> 24 V / DC (ATEX Zone 2/22) <input type="checkbox"/> Ex ia IIC T6 (ATEX Zone 1) Pilot air ports <input type="checkbox"/> Push-in connector <input type="checkbox"/> Thread G 1/8" external ø 6 mm or 1/4" Please specify item no. if known: <input type="text"/> | Limit switches <input type="checkbox"/> mechanical <input type="checkbox"/> Voltage 12-48 V <input type="checkbox"/> Voltage 110-250 V <input type="checkbox"/> inductive <input type="checkbox"/> NAMUR EExi Status <input type="checkbox"/> closed <input type="checkbox"/> open <input type="checkbox"/> open/closed Please specify item no. if known: <input type="text"/> |

continued on next page →

* To find your nearest Bürkert facility, click on the orange box → www.burkert.com

Valve system On/Off Classic Type 8801-YA/8803-YA – request for quotation, *continued*

| Control unit features | |
|---|--|
| Pilot valve | Stroke limitation |
| <input type="checkbox"/> Pilot valve | <input type="checkbox"/> Stroke limitation |
| Power supply <input type="text"/> | <input type="checkbox"/> Min./max. stroke limitation , with visual position indicator |
| | <input type="checkbox"/> Max. stroke limitation , without visual position indicator |
| Please specify item no. if known: <input type="text"/> | Please specify item no. if known: <input type="text"/> |

| Certifications |
|--|
| <input type="checkbox"/> Attestation of compliance with the order EN-ISO 10204 2.1 |
| <input type="checkbox"/> Test report EN-ISO 10204 2.2 |
| <input type="checkbox"/> Certification of Conformity for Raw Material EN-ISO 10204 3.1 |
| <input type="checkbox"/> EN161 (European Gas Device guideline) |

| Comment / sketch |
|------------------|
| |
| |
| |
| |
| |
| |

DTS 1000100702 EN Version: P Status: RL (released | freigegeben | valide) printed: 03.06.2014