

Bargraph Indicators 48N Series

(See 'External View.')

BARGRAPH INDICATING ALARM

(with isolated DC output)

Functions & Features

- Displays a process variable in graphic bargraph of 101 LED segments
- Provides max. 4 alarm contact outputs
- Isolated DC signal output
- Multi-color indicator
- IP65 front cover
- Scale plate is easily replaced
- Separable terminal block

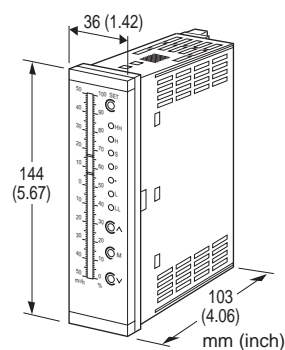

MODEL: 48NAVA-[1][2][3][4][5]-[6][7]

ORDERING INFORMATION

- Code number: 48NAVA-[1][2][3][4][5]-[6][7]
Specify a code from below for each [1] through [7].
(e.g. 48NAVA-42V33-R/CE/D/Q)
- Special input and DC output ranges (For codes Z & 0)
- Bargraph scale (e.g. 0 - 100 %) (See 'Scale Plate.')
- Specify the specification for option code /Q
(e.g. /SET)

[1] ALARM OUTPUT

- 2: 2 points
- 4: 4 points

[2] BAR LED COLOR

- R: Red
- Y: Amber
- G: Green
- B: Blue
- 1: Multi-color (red, orange and green), Pattern 1
(See 'External View.')
- 2: Multi-color (red, orange and green), Pattern 2

[3] MOUNTING DIRECTION

- V: Vertical
- H: Horizontal

[4] INPUT

Current

- A: 4 - 20 mA DC (Input resistance 10 Ω)
- B: 2 - 10 mA DC (Input resistance 20 Ω)
- C: 1 - 5 mA DC (Input resistance 39 Ω)
- D: 0 - 20 mA DC (Input resistance 10 Ω)
- E: 0 - 16 mA DC (Input resistance 12 Ω)
- F: 0 - 10 mA DC (Input resistance 20 Ω)
- G: 0 - 1 mA DC (Input resistance 200 Ω)
- H: 10 - 50 mA DC (Input resistance 5.1 Ω)
- Z: Specify current (See INPUT SPECIFICATIONS)

Voltage

- 3: 0 - 1 V DC (Input resistance 1 MΩ min.)
- 4: 0 - 10 V DC (Input resistance 1 MΩ min.)
- 5: 0 - 5 V DC (Input resistance 1 MΩ min.)
- 6: 1 - 5 V DC (Input resistance 1 MΩ min.)
- 0: Specify voltage (See INPUT SPECIFICATIONS)

[5] DC OUTPUT

Current

- A: 4 - 20 mA DC (Load resistance 550 Ω max.)
- D: 0 - 20 mA DC (Load resistance 550 Ω max.)
- Z: Specify current (See OUTPUT SPECIFICATIONS)

Voltage

- 3: 0 - 1 V DC (Load resistance 1000 Ω min.)
- 4: 0 - 10 V DC (Load resistance 10 kΩ min.)
- 5: 0 - 5 V DC (Load resistance 5000 Ω min.)
- 6: 1 - 5 V DC (Load resistance 5000 Ω min.)
- 0: Specify voltage (See OUTPUT SPECIFICATIONS)

[6] POWER INPUT

AC Power

- M: 85 - 264 V AC (Operational voltage 85 - 264 V, 50/60 Hz
(CE marking not available))
- M2: 100 - 240 V AC (Operational voltage range 85 - 264 V, 50/60 Hz)

DC Power

- R: 24 V DC
(Operational voltage range 24 V ±15 %, ripple 10 %p-p max.)

[7] OPTIONS (multiple selections)

Standards & Approvals

- blank: Without CE
- /CE: CE marking

Bezels

blank: Bezels for M-System's 48 Series panel cutout

/D: Bezels for DIN panel cutout

/F: Bezels for Fuji Electric's PAJ, PAK, PBA panel cutout

Other Options

blank: none

/Q: Option other than the above (specify the specification)

SPECIFICATIONS OF OPTION: Q

EX-FACTORY SETTING

/SET: Preset according to the Ordering Information Sheet (No. ESU-9437)

BEZEL OPTION

Bezels are used to adapt the 48N Series to an existing panel cutout. In order to replace M-System's 48 Series products, use the one attached to the 48N Series as standard. When the existing panel is cut according to DIN standard, specify '/D' suffix code.

For a new installation, no bezel is required. Please refer to 'Mounting Requirement' and mount the 48N directly.

Ingress protection is invalid when the 48N is mounted with a bezel, or when multiple modules are stacked side by side.

SPARE PARTS

- Scale plate

GENERAL SPECIFICATIONS

Construction: Panel flush mounting

Degree of protection: IP65; applicable to the front panel for single unit mounted according to the specified panel cutout

Connection: M3 screw terminals (torque 0.6 N·m)

Screw terminal: Nickel-plated steel

Housing material: Flame-resistant resin (black)

Isolation: Input to DC output to alarm output to power

Display zero adjustment: -10 to +10 %

DC output zero adjustment: -2 to +2 %

Display span adjustment: 90 to 110 %

DC output span adjustment: 98 to 102 %

Scale plate: Flame resistant resin (white scale & characters on black base)

Setpoint adjustment

2 points:

H [L setpoint] to 100 %

L 0 to [H setpoint]

or No alarm trip

4 points:

HH [H setpoint] to 100 %

H [L setpoint] to [HH setpoint]

L [LL setpoint] to [H setpoint]

LL 0 to [L setpoint]

or No alarm trip

Alarm deadband (hysteresis): 1 %

Setting: (Front button)

- Zero and span adjustments
- Alarm setpoint
- Others

(Refer to the instruction manual for details)

Simulated output: Programmable within 0 - 100 %

■ BARGRAPH

LED: 101-segment LED, 100 mm (3.96") long, 3.00 mm (.12") wide

Display range: 0 to 100 (scaling function not available)

Scale: Two different scales available for single bargraph

Characters: Max. 4 characters including decimal point and negative sign

Divisions: Min. 22, max. 100

Engineering unit: Max. 6 characters

INPUT SPECIFICATIONS

■ **DC Current:** 0 - 50 mA DC; input resistor incorporated

Minimum span: 1 mA

When specifying a resistance value, choose from below.

5.1 Ω, 10 Ω, 12 Ω, 20 Ω, 39 Ω, 200 Ω

■ **DC Voltage:** -10 - +10 V DC

Input resistance: ≥ 1 MΩ

Minimum span: 0.1 V

Offset: Max. 1.5 times span

OUTPUT SPECIFICATIONS

■ **DC Current:** 0 - 20 mA DC

Minimum span: 1 mA

Offset: Max. 1.5 times span

Load resistance: Output drive 11 V max.

■ **DC Voltage:** -10 - +10 V DC

Minimum span: 1 V

Offset: Max. 1.5 times span

Load resistance: Output drive 1 mA max.; at ≥ 0.5 V

■ **Alarm Output:** Relay contact

Rated load: 250 V AC @1 A (cos φ = 1)

30 V DC @5 A (resistive load)

Maximum switching voltage: 250 V AC, 220 V DC

Maximum switching power: 380 VA, 150 W

Minimum load: 5 V DC @100 mA

Mechanical life: ≥ 5 × 10⁸ cycles (rate 180 cycles/min.)

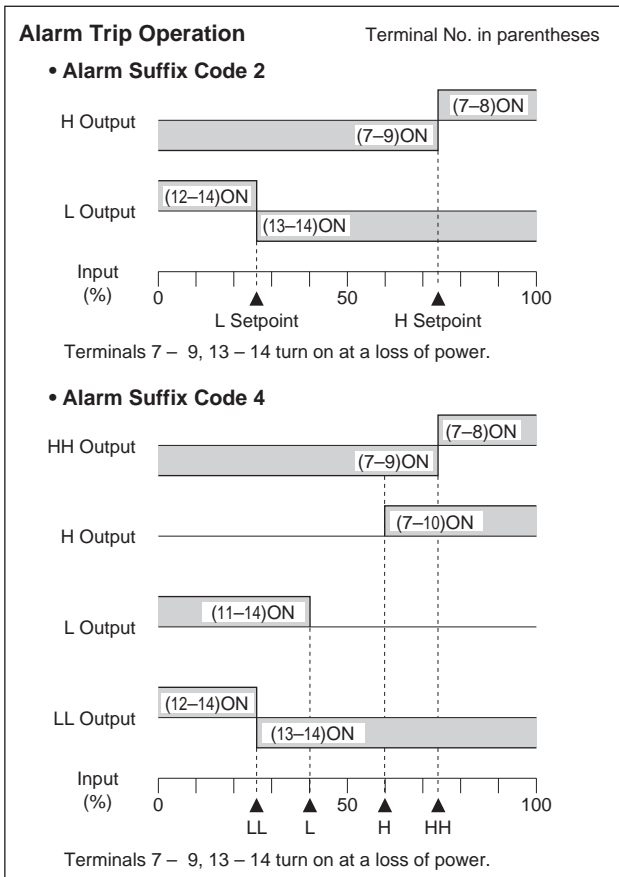

≤ 1.0 sec. (0 – 90 %) (DC output)

Insulation resistance: ≥ 100 MΩ with 500 V DC

Dielectric strength: 2000 V AC @1 min. (input to DC output to alarm output to power to ground)

STANDARDS & APPROVALS

CE conformity:

EMC Directive (2004/108/EC)

EMI EN 61000-6-4: 2007

EMS EN 61000-6-2: 2005

Low Voltage Directive (2006/95/EC)

EN 61010-1: 2001

Installation Category II

Pollution Degree 2

Input to alarm output to power: Reinforced insulation (300 V)

DC output to power: Reinforced insulation (300 V)

INSTALLATION

Power Consumption

• **AC:**

Approx. 5.5 VA at 100 V with max. load

Approx. 7 VA at 200 V with max. load

Approx. 8 VA at 264 V with max. load

• **DC**

Approx. 3.5 W at 20.4 V with max. load

Approx. 3.5 W at 24 V with max. load

Approx. 3.5 W at 27.6 V with max. load

Operating temperature: -5 to +55°C (23 to 131°F)

Operating humidity: 30 to 90 %RH (non-condensing)

Mounting: Panel flush mounting

Weight: 300 g (0.66 lb)

PERFORMANCE in percentage of span

Accuracy:

±1 % ±1 digit (Display)

±0.1 % (DC output)

Temp. coefficient:

±0.015 % of FS/°C (±0.008 % of FS/°F) (Display)

±0.02 %/°C (±0.01 %/°F) (DC output)

Response time:

≤ 0.5 sec. (Display)

SCALE PLATE

■ WHAT MUST BE SPECIFIED WHEN ORDERING

Please specify the bargraph scale range and engineering unit. The overall scale plate design including the number of divisions, division line length, character font is determined by M-System.

[Example] : Bargraph range 0 to 300 cm
 Bargraph scale range: 0 – 300
 Engineering unit for the bargraph: cm

■ TYPES OF DIVISIONS

Five (5) types of divisions are used depending upon the scale span, which determined by the following equation:

$$\text{Scale Span} = (\text{Max. range value} - \text{Min. range value}) \times 10^n$$

where n = integer (used to limit the calculated scale span to the minimum of 1.1, below 11.0.)

The number of divisions is automatically determined by the scale span.

• Type 1: 1.1 Scale Span < 1.3

Number of divisions: 22 to 25.9

Scale: Starts at 0, increments by 0.02 / 0.2 / 2 / 20 / 200. Min. and max. values indicated. 4 digits including negative sign and decimal point.

Division lines: Long, Short, Medium, Short, Long (4 divisions repeated)

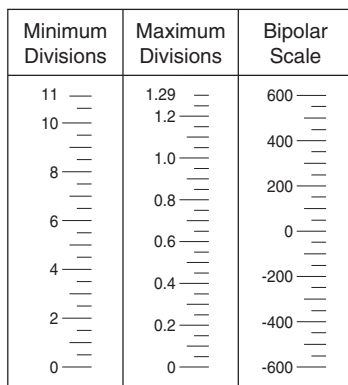

• Type 3: 2.0 Scale Span < 2.6

Number of divisions: 40 to 51.9

Scale: Starts at 0, increments by 0.05 / 0.5 / 5 / 50 / 500. Min. and max. values indicated. 4 digits including negative sign and decimal point.

Division lines: Long, Short, Medium, Short, Medium, Short, Medium, Short, Long (10 divisions repeated)

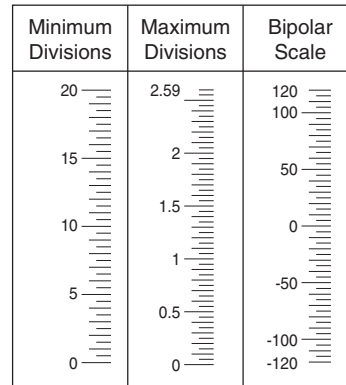

• Type 2: 1.3 Scale Span < 2.0

Number of divisions: 26 to 39.9

Scale: Starts at 0, increments by 0.03 / 0.3 / 3 / 30 / 300. Min. and max. values indicated. 4 digits including negative sign and decimal point.

Division lines: Long, Short, Medium, Short, Medium, Short, Long (6 divisions repeated)

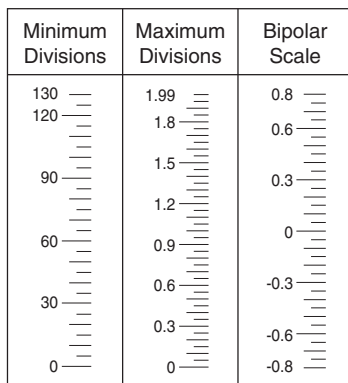

• Type 4: 2.6 Scale Span < 5.5

Number of divisions: 26 to 54.9

Scale: Starts at 0, increments by 0.05 / 0.5 / 5 / 50 / 500. Min. and max. values indicated. 4 digits including negative sign and decimal point.

Division lines: Long, Medium, Medium, Medium, Long (5 divisions repeated)

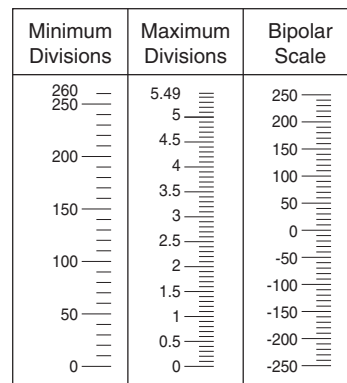

• **Type 5: 5.5 Scale Span < 11.0**

Number of divisions: 27.5 to 54.9

Scale: Starts at 0, increments by 0.01 / 0.1 / 1 / 10 / 100 / 1000. Min. and max. values indicated.

4 digits including negative sign and decimal point.

Division lines: Long, Medium, Medium, Medium, Medium, Long (5 divisions repeated)

[Example] : Bargraph range 0 to 300 cm (Type 4)

Left scale range: 0 – 300

Left scale unit (bargraph): cm

Right scale: None

Minimum Divisions	Maximum Divisions	Bipolar Scale
550	10.9	0.5
500	10	0.4
	9	0.3
400	8	0.2
	7	0.1
300	6	0
	5	-0.1
200	4	-0.2
	3	-0.3
100	2	-0.4
	1	-0.4
0	0	-0.5



EXTERNAL VIEW

■ ALARM SUFFIX CODE 2: 2 points

• Vertical Mounting

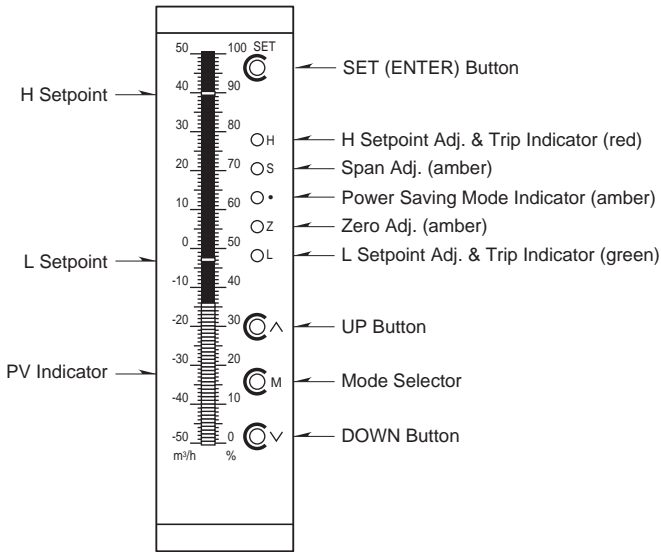

• Horizontal Mounting

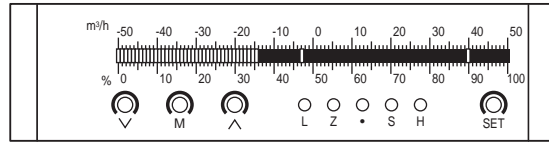

■ ALARM SUFFIX CODE 4: 4 points

• Vertical Mounting

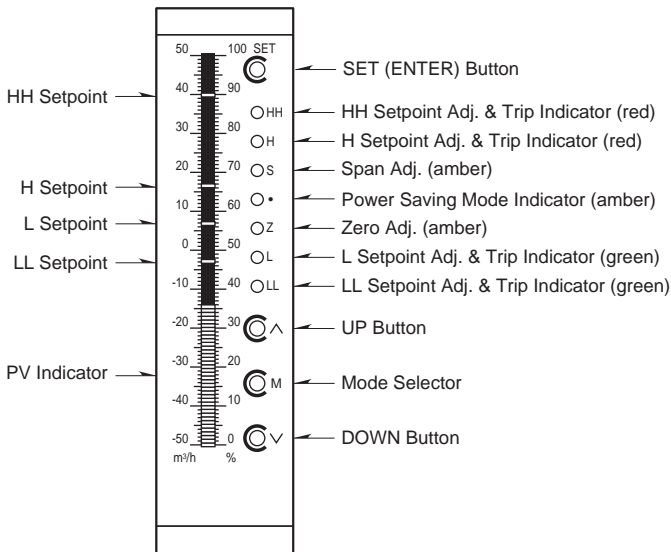

• Horizontal Mounting

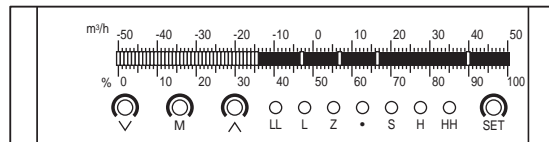

• Bar Color Patterns

Pattern 1 (model suffix code 1)

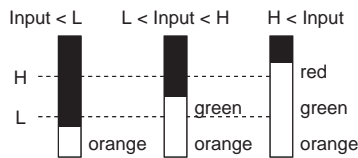

Pattern 2 (model suffix code 2)

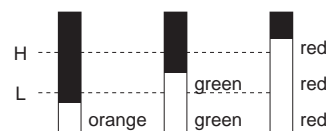

DIMENSIONS unit: mm (inch)

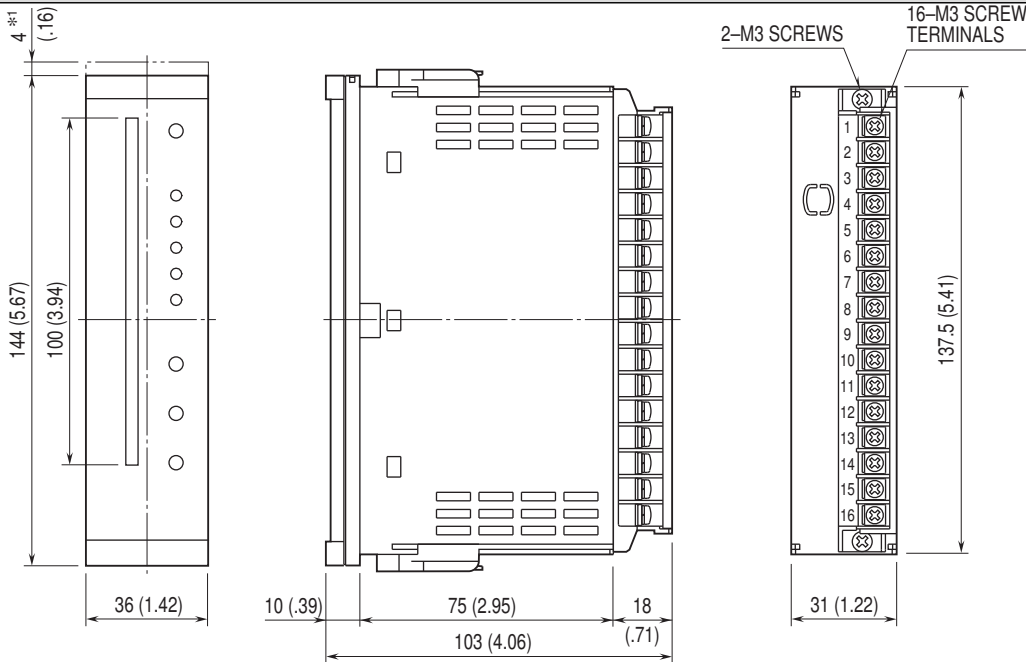

STANDARD BEZEL *2

OPTION /D BEZEL *3

OPTION /F BEZEL *4

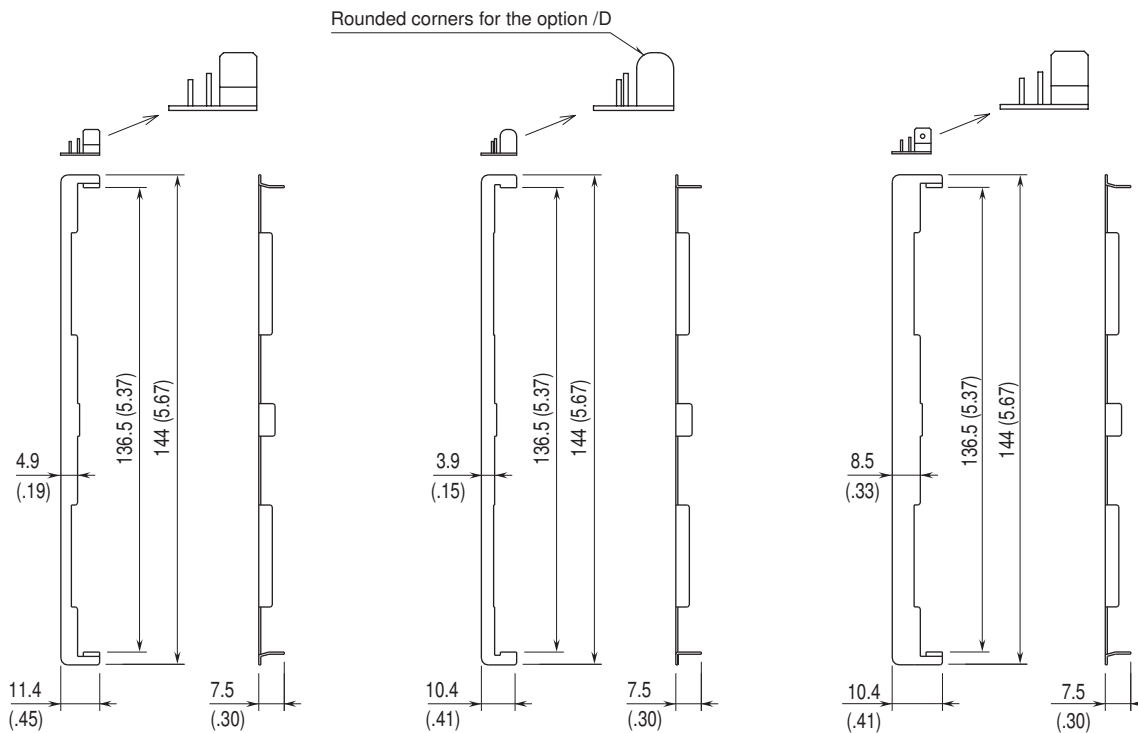

- *1. Space required when replacing the scale plate.
- *2. Used for the existing panel cutout of M-System 48 Series (38 × 139.5 mm).
- *3. Used for the existing DIN panel cutout (33 × 138 mm)
- *4. Used for the existing panel cutout of Fuji Electric PAJ, PAK, PBA (44 × 138 mm), etc.

PANEL CUTOUT unit: mm

■ SINGLE MOUNTING (ingress protection)

• Vertical Mounting

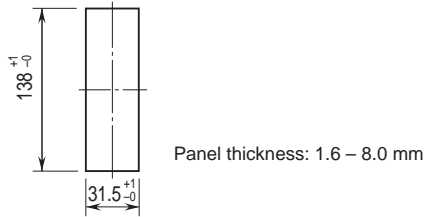

• Horizontal Mounting

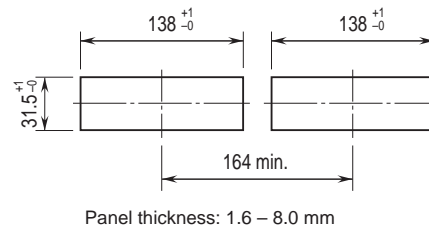

■ CLUSTERED MOUNTING (no ingress protection)

• Vertical Mounting

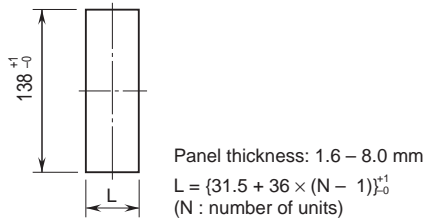

• Horizontal Mounting

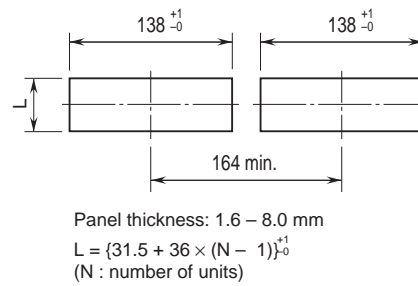

Note 1. Observe at the minimum of 3 cm above and below the units for heat dissipation.
 Note 2. No bezel is needed when the panel is cut according to the above drawings.

SCHEMATIC CIRCUITRY & CONNECTION DIAGRAM

■ ALARM SUFFIX CODE 2: 2 points

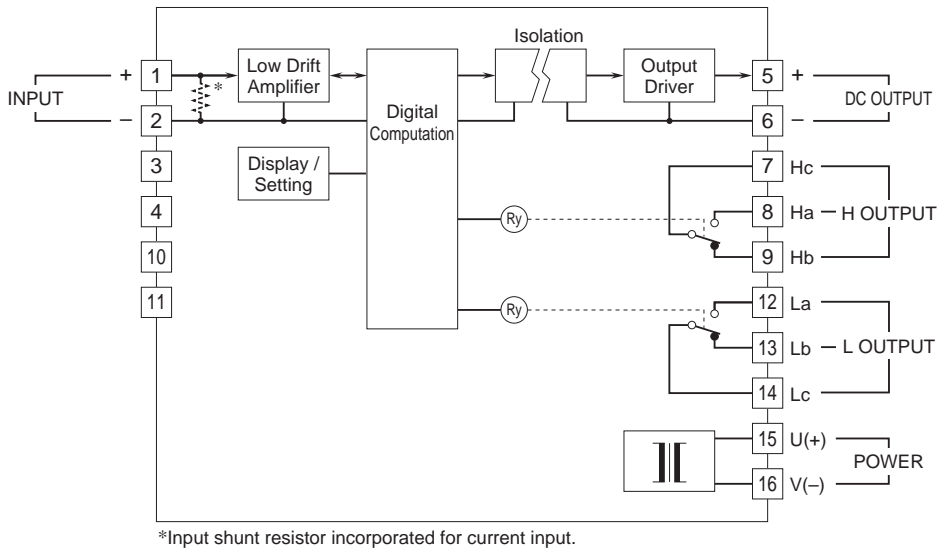

■ ALARM SUFFIX CODE 4: 4 points

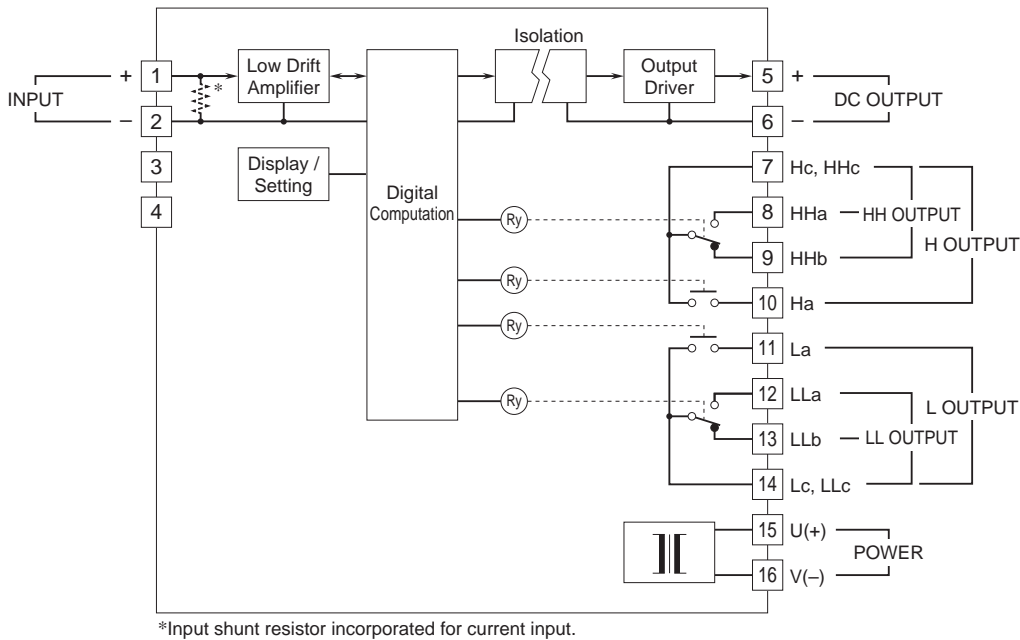

■ Relay Protection

• AC Powered

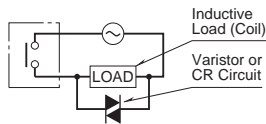

• DC Powered

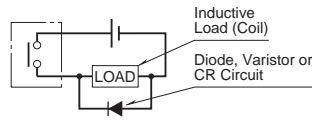

Specifications are subject to change without notice.